









FASTFIX Frame for Wall Hung WCs

Includes pan connectors with top and front access, dual flush compact cistern and rectangular or circular flush plate (excluding WC pan)

CODE (Circular)	Chrome		TO64113P47	White		TO64113P48
	Black		TO64113P49	Brushed Gold		USW0506
	Brushed Nickel		USW0507			
CODE (Rectangular)	Chrome		TO64113P43	White		TO64113P44
	Black		TO64113P45			
MATERIAL	Frame: Steel		Cistern: Plastic			
FLUSH VOLUME	6/4 or 4/2.6 Litres					
STANDARDS	EN14055					
FIXINGS	Secure to floor and upright structures using fixings provided					
DIMENSIONS	W420 x H780-980 x D155-185mm					
WEIGHT	14.56KG					
ADDITIONAL INFO	Suitable for use with stud walls where adequate grounds are provided. Load capacity 400KG.					

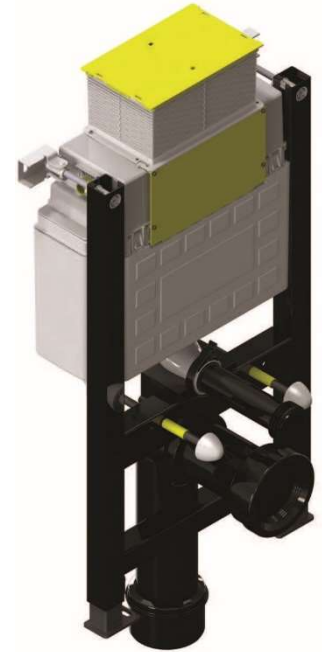

Chrome Circular

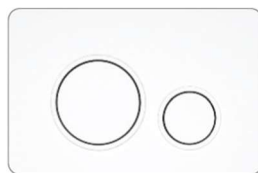

White Circular



Black Circular



Brushed Gold Circular



Brushed Nickel Circular

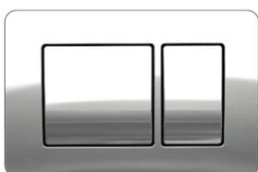

Chrome Rectangular



White Rectangular



Black Rectangular

